

ASSEMBLY INSTRUCTION

#14-1304

#22072:Front legs(left)
#22073:Front legs(right)

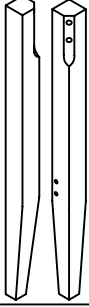

1 x #22072
1 x #22073

#22074:Back legs(left)
#22075:Back legs(right)

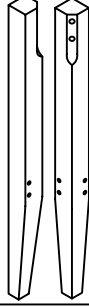

1 x #22074
1 x #22075

#22076:Short cross member

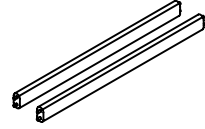

2 x #22076

#22077:Long cross member

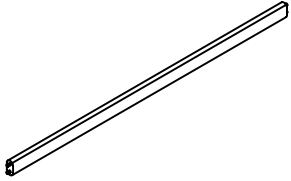

1 x #22077

#22078:Desk

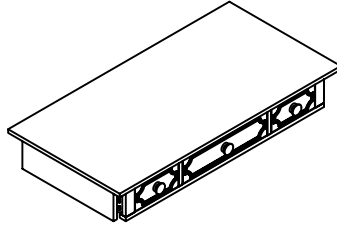

1 x #22078

#20018: Hex wrench 5mm

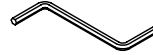

1 x #20018

#22097: M8x35mm hex bolt

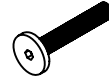

8 x #22097

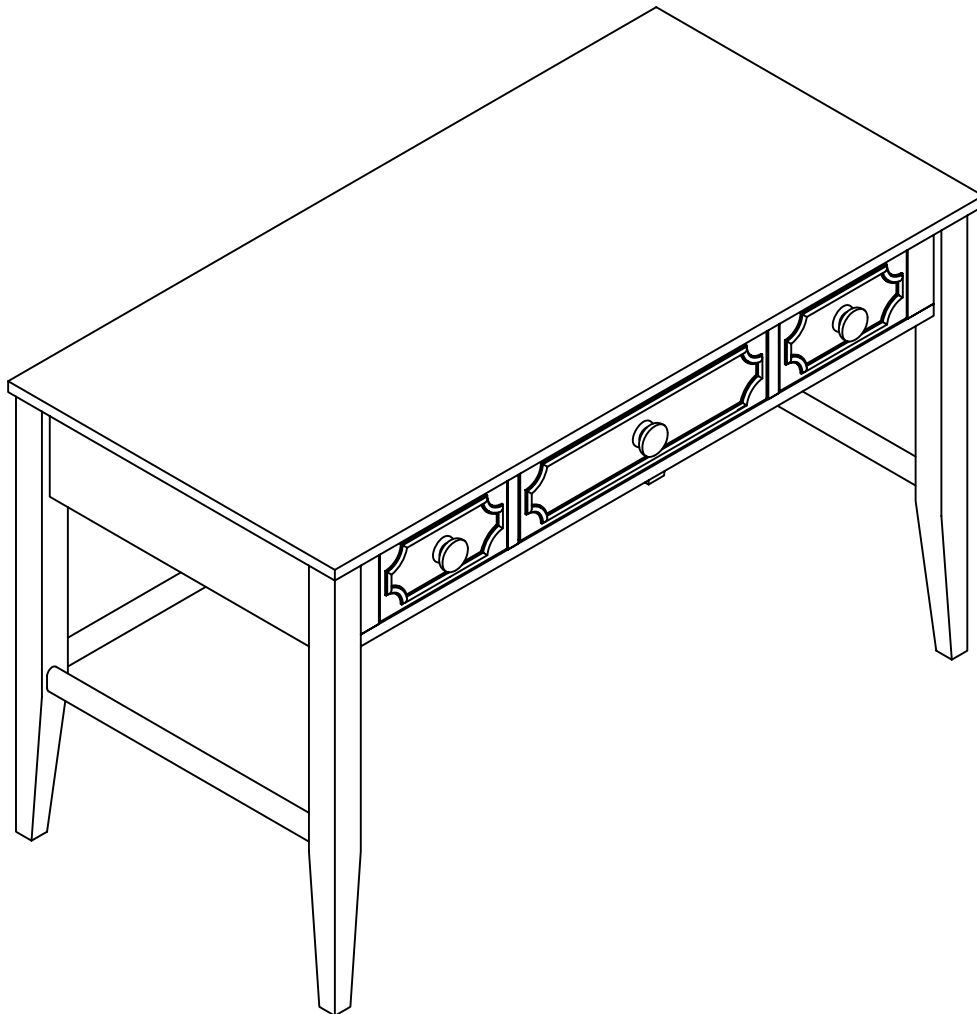

Maxwood Furniture

578 EAST BAY St., SUITE C, CHARLESTON SC., 29403,USA

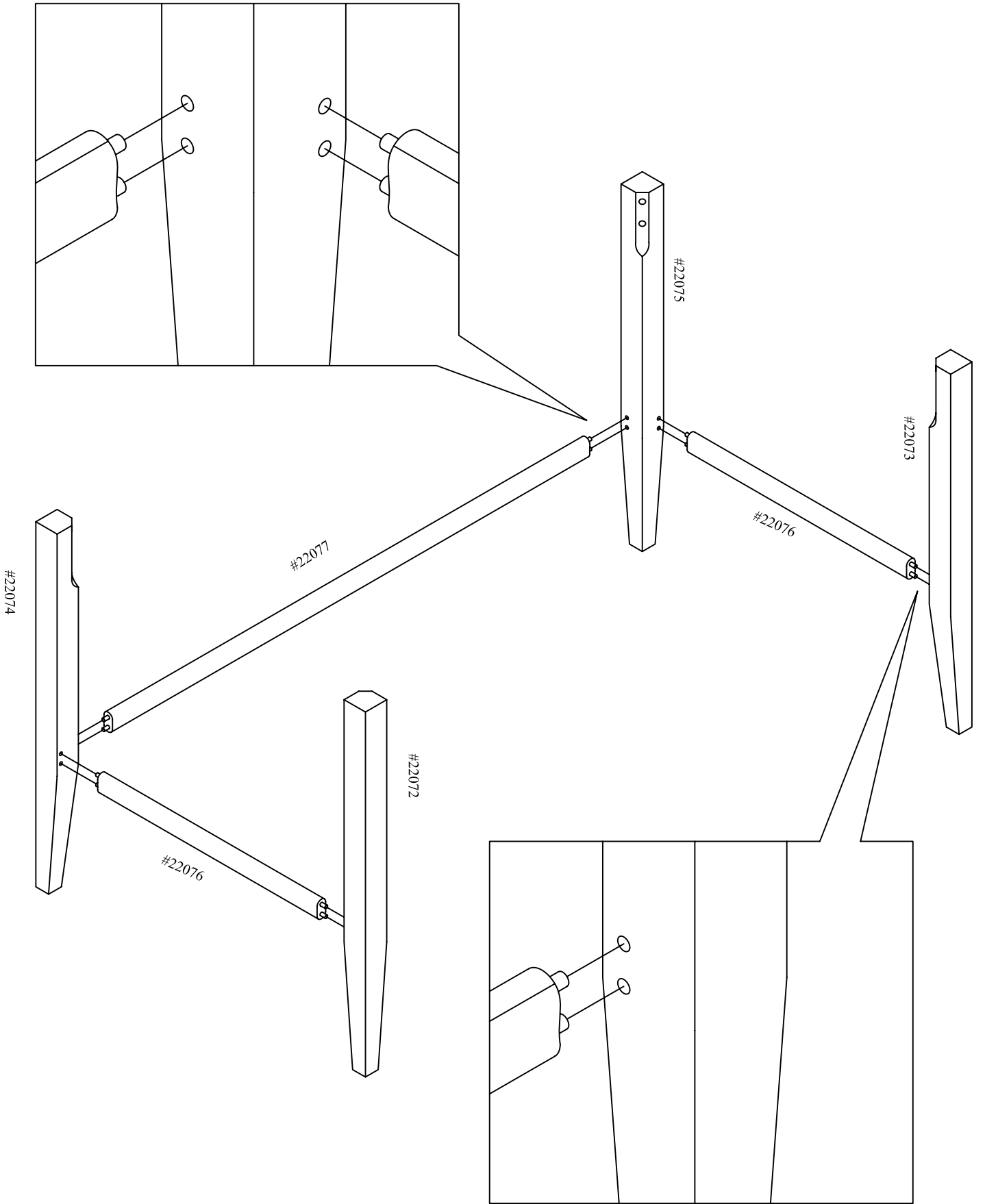

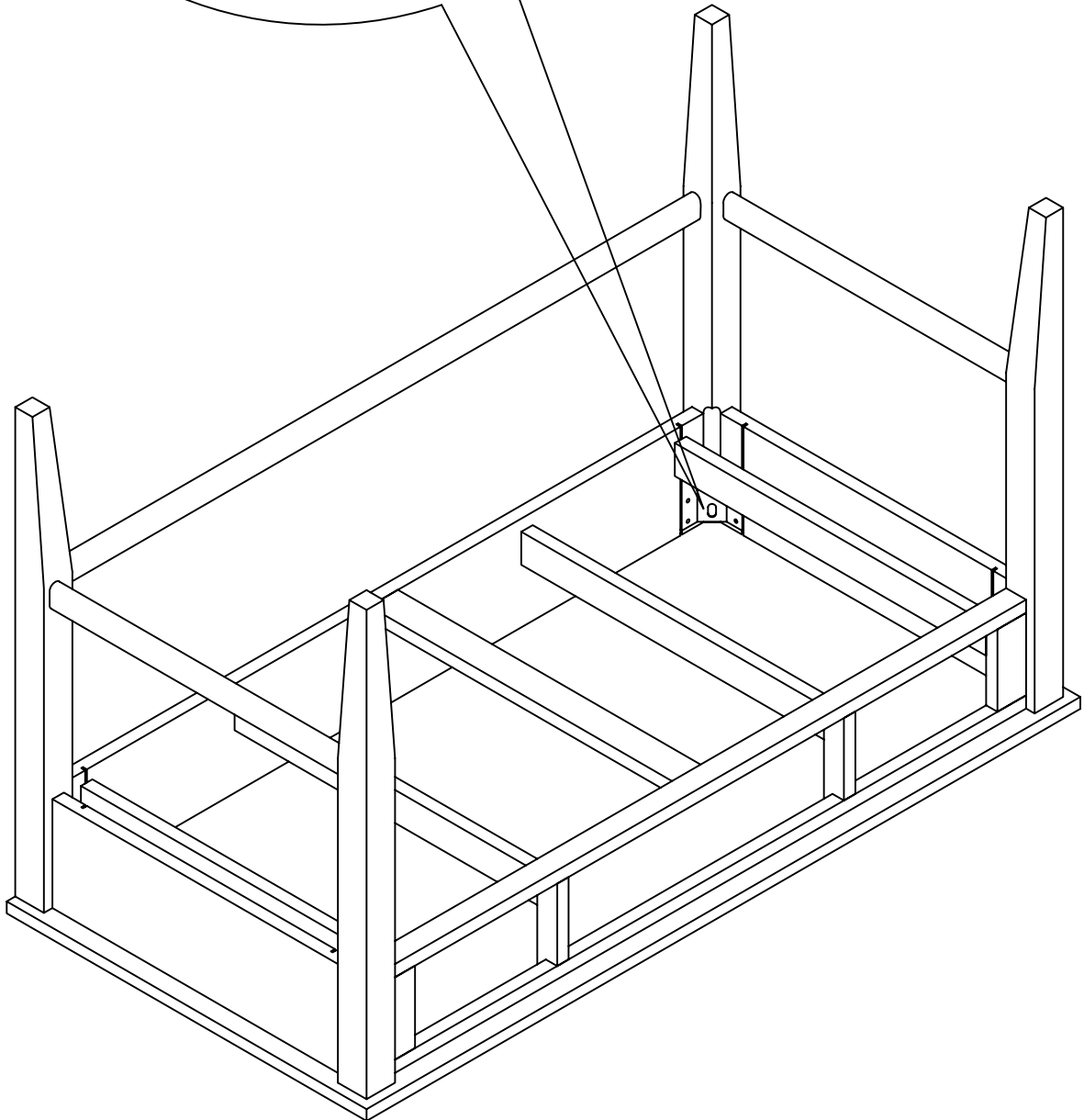
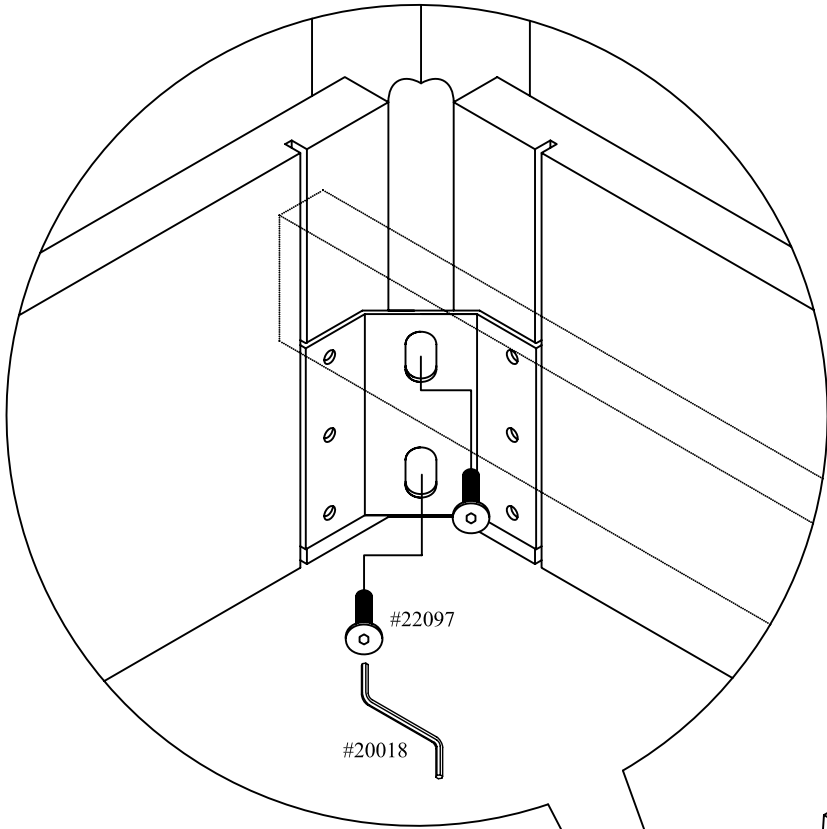

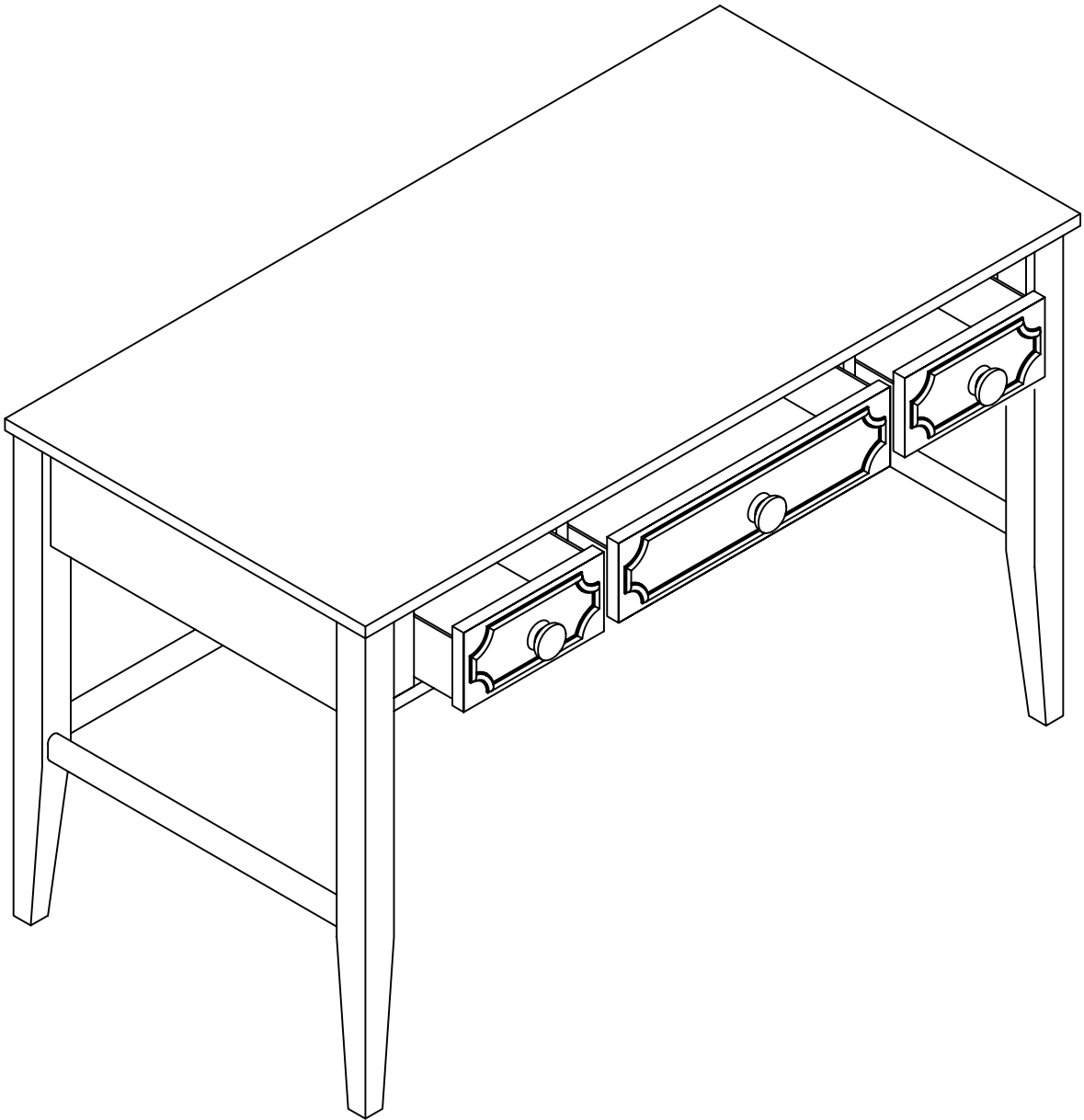

Replacement Parts:

Replacement Parts may be obtained from any of our dealers.

Size of Mattress:

This bed is designed to use a mattress 74" – 75" (188cm – 191cm) long and 37½" – 38½" (95cm – 98cm) wide (Standard Twin size).

IMPORTANT:

Always remember to check and tighten loose bolts or hardware every month, as these may loosen with use over time.